

Recording the path-time diagrams of linear motions

Recording and evaluating with VideoCom

Objects of the experiments

- Recording and evaluating uniform motions on Fletcher's trolley with VideoCom.
- Recording and evaluating uniformly accelerated motions on Fletcher's trolley with VideoCom.

Principles

In the case of uniform motion, a mass point covers equal distances Δs on a straight line in equal time intervals Δt . Its velocity

$$v = \frac{\Delta s}{\Delta t} \quad (I)$$

has a constant value. For determining the velocity, an arbitrary time interval Δt can be chosen in which the distance Δs is measured.

If the motion is not uniform, the velocity changes in the course of time and Eq. (I) gives the mean value of the velocity during the time interval Δt . For determining the instantaneous velocity at a time t , the time interval Δt has to be chosen as small as possible. Therefore it is more precise to define the velocity as the limit

$$v(t) = \lim_{\Delta t \rightarrow 0} \frac{s(t + \Delta t) - s(t)}{\Delta t} = \frac{ds}{dt} \quad (II)$$

The quantity

$$a = \frac{\Delta v}{\Delta t} \quad (III)$$

is the acceleration of the mass point. For a uniformly accelerated motion it is constant. Otherwise the acceleration at the time t is more precisely defined as the limit

$$a(t) = \lim_{\Delta t \rightarrow 0} \frac{v(t + \Delta t) - v(t)}{\Delta t} = \frac{dv}{dt} \quad (IV)$$

In the experiment, uniform and uniformly accelerated motions of a trolley are recorded by means of the single-line CCD camera VideoCom (CCD: charge-coupled device). The trolley, to which retroreflecting foil is attached, is illuminated by VideoCom with LED flashes. Via a camera lens the reflected flashes are imaged on a CCD line with 2048 pixels. Up to 80 times per second the instantaneous position of the trolley is transmitted to a computer via a serial interface. The duration of the flashes, which is set automatically, is 1/800 s at most so that a "quick" motion on the track is imaged sharply.

The software enclosed with VideoCom records the entire motion of the trolley as a path-time diagram and makes possible further evaluation of the measured data. In particular calculation of the velocity

$$v(t) = \frac{s(t + \Delta t) - s(t - \Delta t)}{2 \cdot \Delta t} \quad (V)$$

and the acceleration

$$a(t) = \frac{v(t + \Delta t) - v(t - \Delta t)}{2 \cdot \Delta t} \quad (VI)$$

can be enabled by a mouse click, whereby there are several options for the time interval Δt .

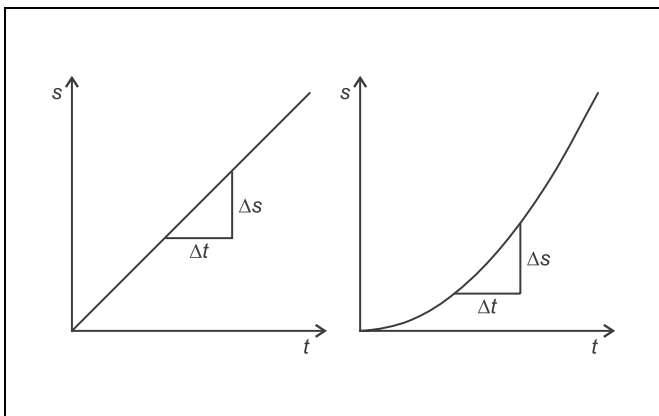

Fig. 1 Path-time diagram of the uniform (left) and the uniformly accelerated (right) motion

Apparatus

1 track	337 130
1 trolley	337 110
1 VideoCom	337 47
1 plug-in unit 230 V/12 VAC/20 W	562 791
1 camera tripod	300 59
1 holding magnet	683 41
1 holder for combi-spoked wheel	337 463
1 combi-spoked wheel	337 464
1 plate for weights with slot, 10 g	315 410
4 weights with slot, 10 g	315 418
1 cord, 10 m	309 48
connection leads	
<i>additionally recommended:</i>	
1 pair of additional weights	337 114
<i>additionally required:</i>	
1 PC with Windows 95/NT or higher version	



- Select "Intensity Test" in the "VideoCom Motions" program.
- In order to reduce the background, slightly darken the room.
- Align the VideoCom so that two peaks are seen on the LC display of the camera housing.
- Get rid of unwanted light and reflections so that no other peaks are seen.
- Improve the alignment until the ratio of the intensities of the peaks and the background is greater than 5:1.

Connecting the holding magnet:

- Attach the cord to the thread holder (**b₂**) of the trolley, guide it over the combi-spoked wheel (which serves as a guide pulley), and suspend the plate for the weight with slot 10 g (**e**) from it.
- Adjust the iron core of the holding magnet with the knurled screw so that the trolley is just kept and starts running as soon as the key START at the VideoCom housing is pushed.

Correction of the distortion:

- Change to "Path" in the "VideoCom Motions" program.
- Attach another strip of retroreflecting foil vertically to the trolley at a distance of 5 cm from the first strip.
- Call the menu "Settings/Path Calibration" with the  button or the key F5.
- Enter the values 0 and 0.05 m for the positions of the two strips of foil in the register "Path Calibration".
- Click the button "Read Pixels from Display", and enable "Apply Calibration".
- Call the menu "Settings/Path Calibration" again, and enter the following settings in the register "Measuring Parameters":

Δt	50 ms (20 fps)
Flash	Auto
Smoothing	Standard (4*dt)
Measurement Stop	At End of Path
s	e.g. 0.9 m
- Start the measurement with the  button or with the key F9, and record the motion of the trolley.
- Next click the button "Suggest linearization" in the register "Linearization" of the menu "Settings/Path Calibration".
- If an angle $\alpha \neq 0^\circ$ is displayed, the angle between the track and the VideoCom is not yet correct (see Fig. 3):
- Dismiss the linearization with the button "Cancel".
- Shift the right foot of the track to adjust the track's position.
- Erase the old measured values with the  button or with the key F4, record the motion of the trolley once more, and determine the angle α again.
- Repeat the procedure until $\alpha = 0^\circ$ is displayed; then enable "Apply Linearization" and accept the distortion δ .

Setup

The experimental setup is illustrated in Fig. 2.

Setting up the track:

- Use a clamping rider to attach the holding magnet (**a**). If necessary, remove the rubber strip.
- Fasten the combi-spoked wheel in the holder for combi-spoked wheel (**d**) at the end of the track.
- Align the track horizontally with the adjusting screws (**f**).
- Put the trolley on the track, and check the horizontal alignment.

Setting up VideoCom:

- Screw VideoCom onto the camera tripod, set it up at a distance of approx. 2 m from the track, and align it at equal height parallel to the track rail.
- Supply VideoCom with power via the plug-in unit, and connect it to a serial input of the PC (e.g. COM1).
- Connect the holding magnet to VideoCom via two connection leads.
- If necessary, install the software enclosed with VideoCom, call the program "VideoCom Motions", and, if you wish, select the desired language and serial interface (see instruction sheet of VideoCom).

Aligning VideoCom:

- Equip the trolley with the holding plate (**b₁**), and move it to the holding magnet.
- Attach retroreflecting foil (**b₃**) vertically to one edge of the trolley.
- Attach retroreflecting foil (**c₃**) to the end buffer as well, and clamp the buffer so that the distance between the two strips of foil is exactly 1 m.

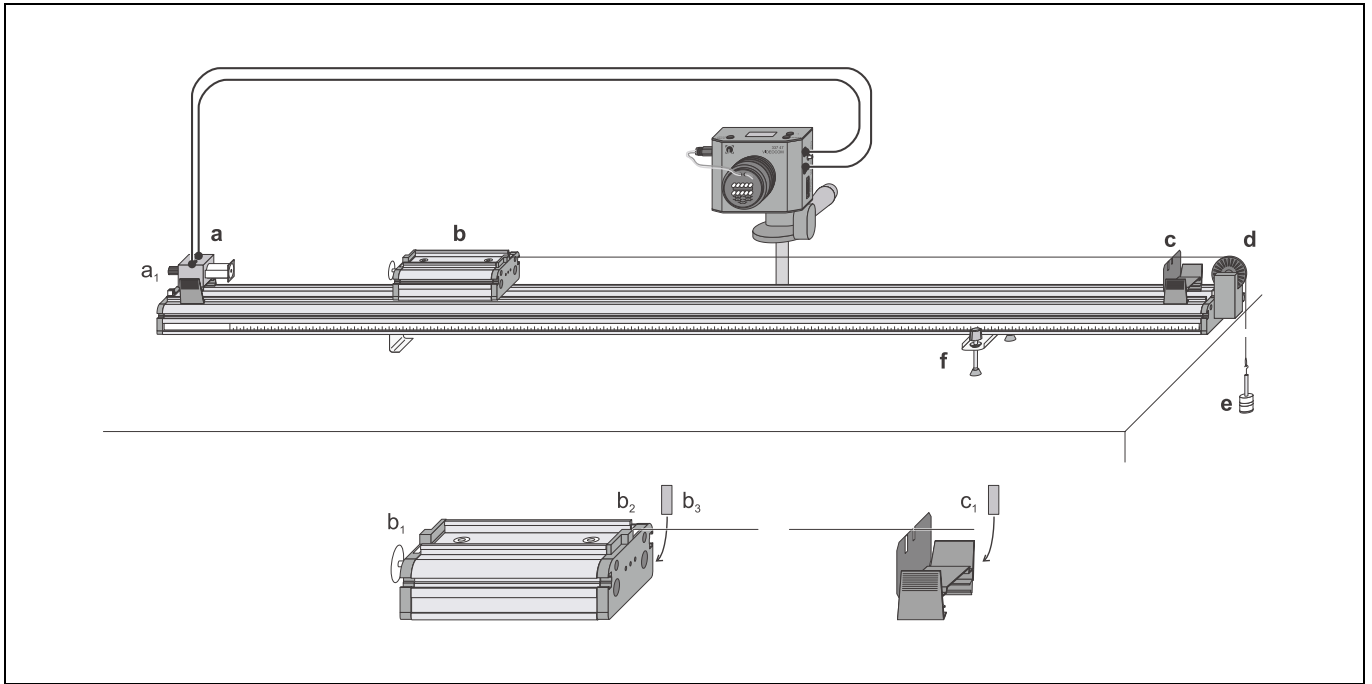
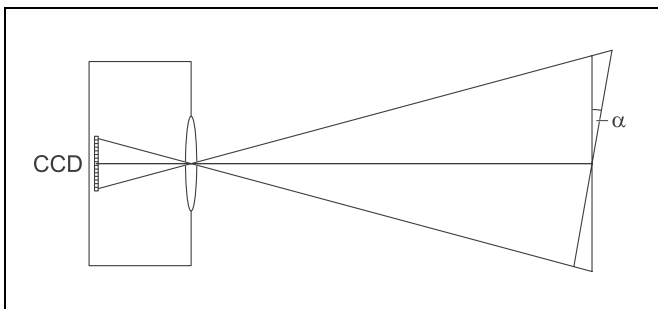

Fig. 2 Experimental setup for recording motions with VideoCom

Fig. 3 Diagram illustrating the definition of the angle α between the track and the VideoCom.





Path calibration:

- Remove the second retroreflecting foil from the trolley, move the trolley to the holding magnet, and place the end buffer on the track so that the distance between the retro-reflecting foils is exactly 1 m.
- Enter 0 m and 1 m for the positions of the two foils in the register "Path Calibration" of the menu "Settings/Path Calibration".
- Click the button "Read Pixels from Display", and enable "Apply Calibration".

Carrying out the experiment

a) Uniform motion:

- Erase the old measured values with  or F4.
- Remove the cord from the trolley, and move the trolley near the holding magnet.
- Slightly give the trolley a push with a finger. Then start the measurement with  or F9, and record the path-time diagram.
- Store the measured values with  or F2. Use a file name that allows you to recognise the file.

b) Uniformly accelerated motion:

- Erase the old measured values.
- Attach the cord to the thread holder again with the plate for weights with slot 10 g suspended, and guide the cord over the guide pulley.
- Move the trolley to the holding magnet, start the measurement, and record the path-time diagram.
- Store the measured values with  or F2. Use a file name that allows you to recognise the file.

c) Accelerated motion as a function of the accelerating force F :

- Erase the old measured values, and remove the weights with slot 10 g.
- Attach the cord to the thread holder again with the plate for weights with slot 10 g suspended, and guide the cord over the guide pulley.
- Move the trolley to the holding magnet, start the measurement, and record the path-time diagram.
- One after another add up to four additional weights with slot 10 g, and each time record the path-time diagram.
- Store the measured values with  or F2. Use a file name that allows you to recognise the file.

d) Accelerated motion as a function of the accelerated mass m :

- Erase the old measured values.
- Attach the cord to the thread holder again with the plate for weights with slot 10 g suspended and with two additional weights with slot 10 g, and guide the cord over the guide pulley.
- Move the trolley to the holding magnet, start the measurement, and record the path-time diagram
- If possible, repeat the measurement with additional weights 500 g.
- Store the measured values with  or F2. Use a file name that allows you to recognise the file.

Measuring examples and evaluation

a) Uniform motion:

Fig. 4 shows the path-time diagram of the trolley in the case of a uniform motion without external force. The path s covered is a linear function of the time t as is confirmed by fitting a straight line to the measured values.

By clicking the register "Velocity", the instantaneous velocity v is calculated as a function of the time. This velocity is virtually constant (see Fig. 5), but slightly decreases in the course of time as the trolley is slowed down by friction.

b) Uniformly accelerated motion:

Fig. 6 shows the path-time diagram of the trolley when it is accelerated by a constant force F . Here the path s covered is not a linear function of the time t as is confirmed by fitting a parabola to the measured values.

The instantaneous velocity v calculated from the measured values is a linear function of the time (see Fig. 7), and the instantaneous acceleration a is almost constant (see Fig. 8). Considered more closely, the acceleration slightly decreases in the course of t because the friction increases with increasing velocity.

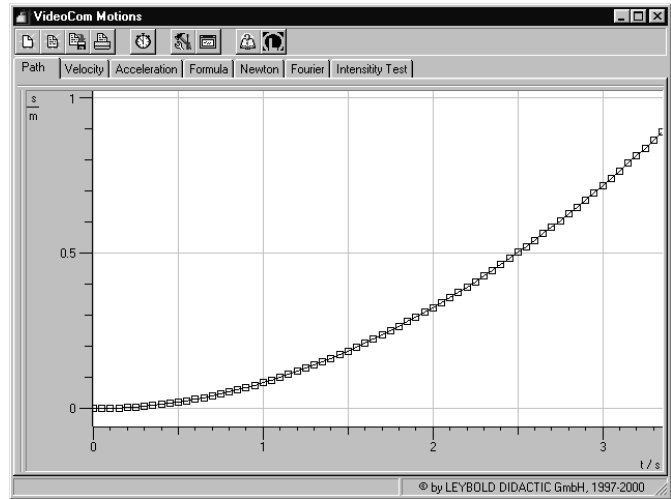

Fig. 6 Path-time diagram of a uniformly accelerated motion of the trolley, recorded with VideoCom.

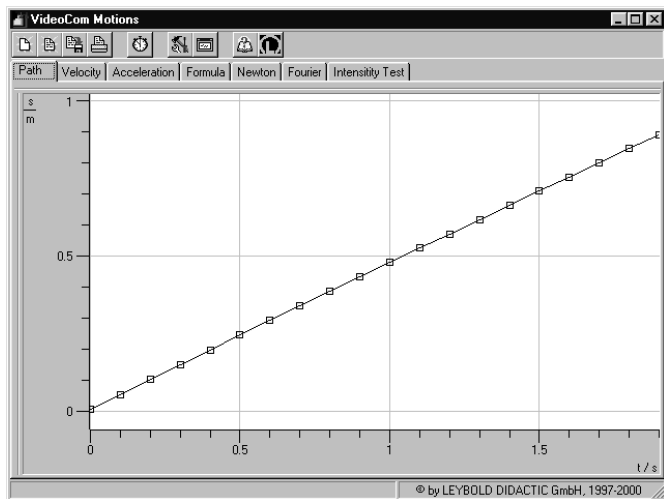

Fig. 4 Path-time diagram of a uniform motion of the trolley, recorded with VideoCom.

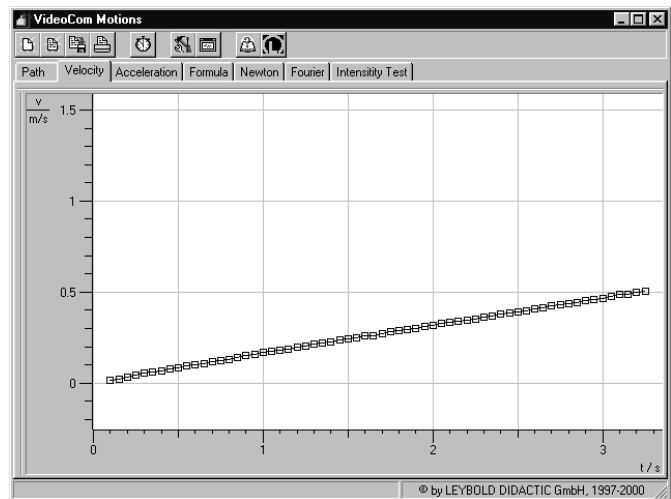
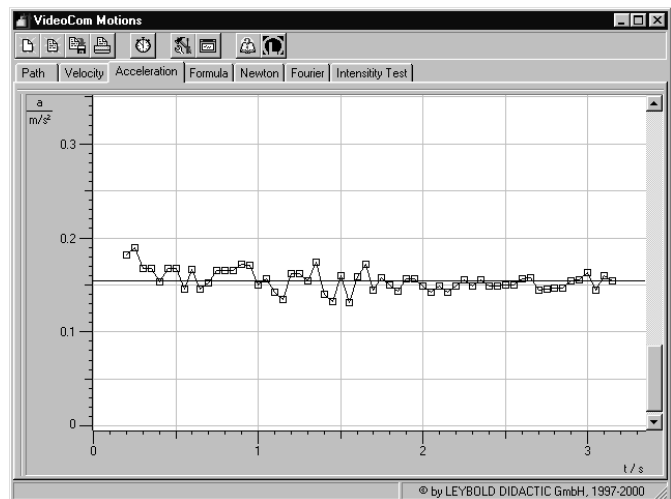
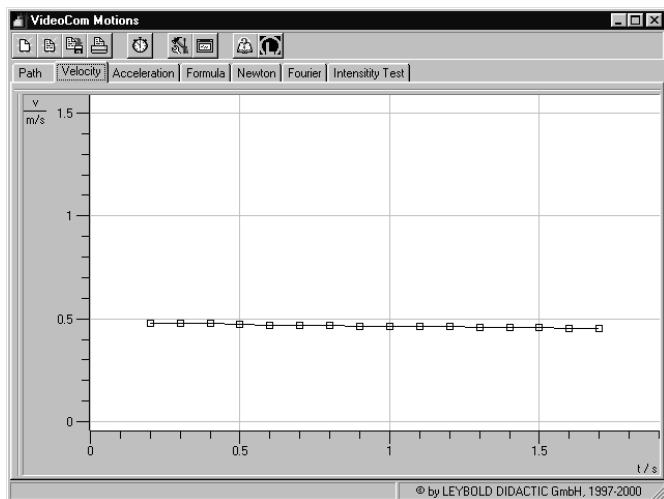

Fig. 7 Velocity-time diagram, corresponding to Fig. 6

Fig. 5 Velocity-time diagram, corresponding to Fig. 4

Fig. 8 Acceleration-time diagram, corresponding to Fig. 6



c) Accelerated motion as a function of the accelerating force F :

The accelerated motion of the trolley in the case of different accelerating forces F is shown in Fig. 9. Fig. 10 shows the acceleration calculated from the measured values as a function of the time.

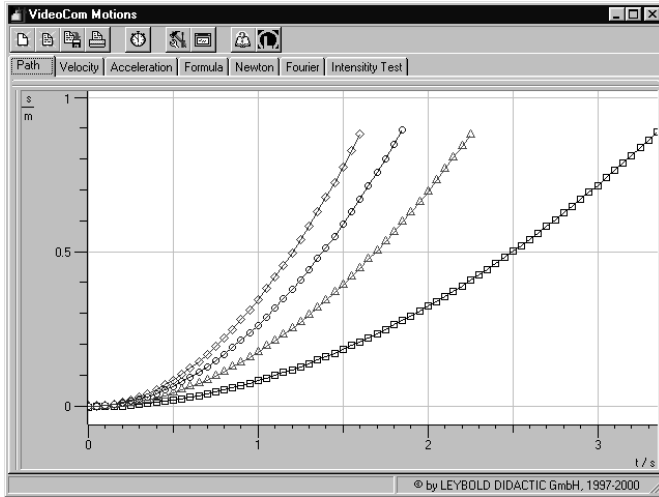
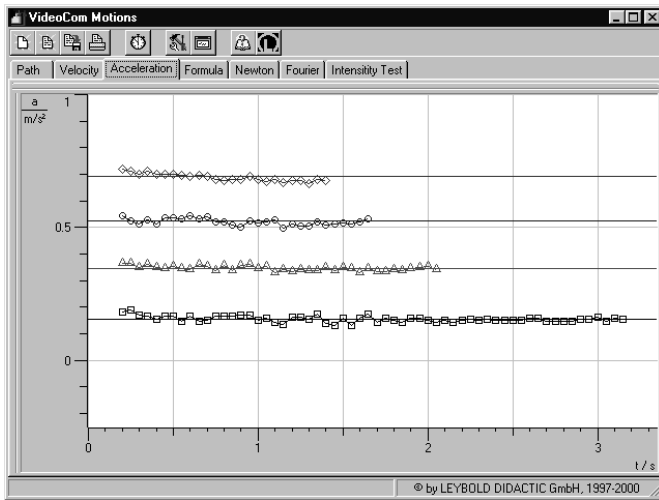

Fig. 9 Path-time diagram of the uniformly accelerated motion. ($F = 0.098 \text{ N}$ (\square), 0.196 N (\triangle), 0.294 N (\circ), 0.392 N (\diamond)).

Fig. 10 Acceleration-time diagram, corresponding to Fig. 9



d) Accelerated motion as a function of the accelerated mass m :

The accelerated motion in the case of a constant force and different masses m is shown in Fig. 11. Fig. 12 shows the acceleration calculated from the measured values.

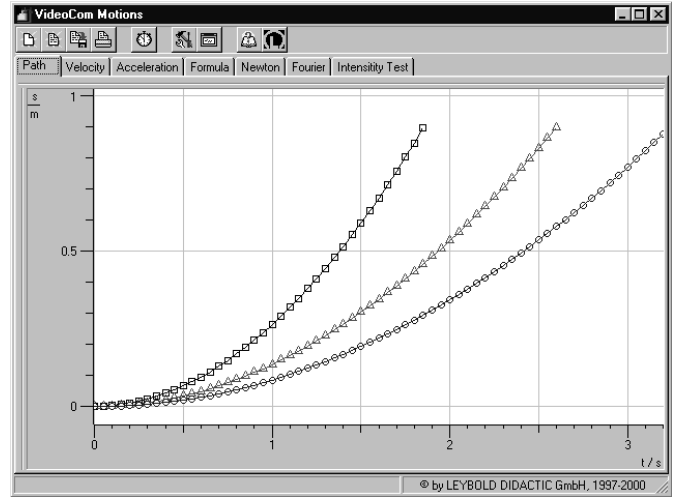

Fig. 11 Path-time diagram of the uniformly accelerated motion in the case of a constant accelerating force $F = 0.294 \text{ N}$ ($m = 530 \text{ g}$ (\square), 1030 g (\triangle), 1530 g (\circ)).

Fig. 12 Acceleration-time diagram, corresponding to Fig. 11

